

Scissors





RS-5600

McPHERSON-VANNAS
straight, sharp
cutting edge 5mm
tip width 0.15mm
overall length 3"



RS-5601

McPHERSON-VANNAS
curved, sharp
cutting edge 5mm
tip width 0.15mm
overall length 3"



RS-5602

McPHERSON-VANNAS
straight, sharp
cutting edge 5mm
tip width 0.1mm
overall length 3"



RS-5603

McPHERSON-VANNAS
curved, sharp
cutting edge 5mm
tip width 0.1mm
overall length 3"



RS-5604

McPHERSON-VANNAS
straight
sharp needle points
cutting edge 3mm
tip width 0.15mm
overall length 3"



RS-5605

McPHERSON-VANNAS
curved
sharp needle points
cutting edge 3mm
tip width 0.15mm
overall length 3"



RS-5630 McPHERSON-VANNAS
 straight
 cutting edge 6mm
 tip width 0.15mm
 overall length 4"



RS-5631 McPHERSON-VANNAS
 curved
 cutting edge 6mm
 tip width 0.15mm
 overall length 4"



RS-5610 VANNAS
 straight
 cutting edge 3mm
 tip width 0.15mm
 overall length 3"



RS-5611 VANNAS
 curved
 cutting edge 3mm
 tip width 0.15mm
 overall length 3"



RS-5618 VANNAS
 angled on edge
 cutting edge 3mm
 tip width 0.15mm
 overall length 3"



RS-5619 VANNAS
 angled on flat
 cutting edge 3mm
 tip width 0.15mm
 overall length 3"

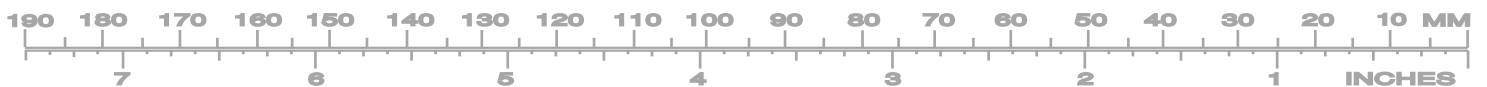



RS-5620

VANNAS
straight
cutting edge 3mm
tip width 0.1mm
overall length 3"



RS-5621

VANNAS
curved
cutting edge 3mm
tip width 0.1mm
overall length 3"



RS-5650

CASTROVIEJO
straight, sharp
cutting edge 9mm
tip width 0.15mm
overall length 3¹/₂"



RS-5658

CASTROVIEJO
angular, sharp
cutting edge 9mm
tip width 0.15mm
overall length 3¹/₂"



RS-5668

CASTROVIEJO
angular, blunt
cutting edge 9mm
tip width 0.15mm
overall length 3¹/₂"



RS-5671

CASTROVIEJO
curved, sharp
cutting edge 10mm
tip width 0.15mm
overall length 3³/₄"

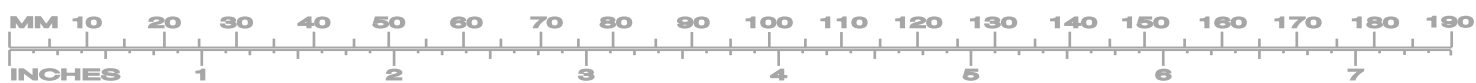

RS-5673 CASTROVIEJO
 curved, blunt
 cutting edge 10mm
 tip width 0.15mm
 overall length 3¹/₂"



RS-5674 CASTROVIEJO
 13mm blades
 angled on flat, blunt
 tip width 0.25mm
 overall length 4¹/₂"



RS-5675 NOYES
 slightly curved, sharp
 cutting edge 13mm
 tip width 0.25mm
 overall length 4¹/₂"



RS-5676 NOYES
 straight, sharp
 cutting edge 13mm
 tip width 0.25mm
 overall length 4¹/₂"



RS-5677 NOYES
 straight, sharp-blunt
 cutting edge 13mm
 tip width 0.25mm
 overall length 4¹/₂"



RS-5678 NOYES
 straight, blunt-blunt
 cutting edge 13mm
 tip width 0.35mm
 overall length 4¹/₂"

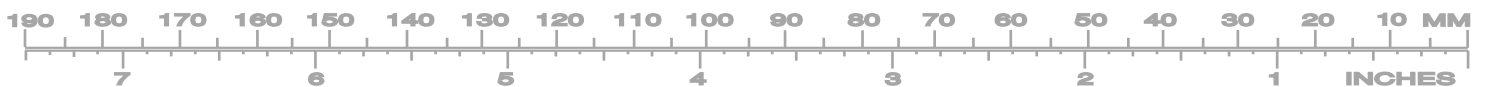

RS-5788

NOYES
 angled on flat
 12mm blades
 tip width 0.2mm
 length 4^{3/4}"



RS-5680

Micro Dissecting
 straight, 8mm blades
 flat handle
 tip width 0.15mm
 overall length 6"



RS-5681

Micro Dissecting
 curved, 8mm blades
 flat handle
 tip width 0.15mm
 overall length 6"



RS-5692

Micro Dissecting
 straight, 6mm blades
 round handle
 tip width 0.15mm
 overall length 6"

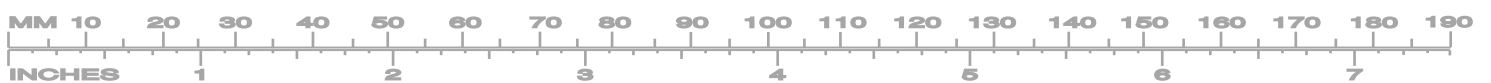

RS-5693

McCLURE
Micro Dissecting
curved, 6mm blades
round handle
tip width 0.15mm
overall length 6"

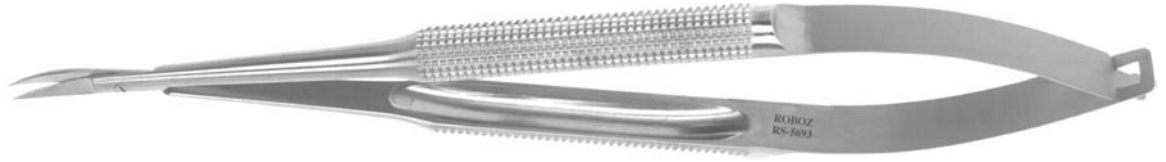

RS-5802

DeWECKER
sharp-sharp
7mm blades
tip width 0.2mm
length 4 1/4"

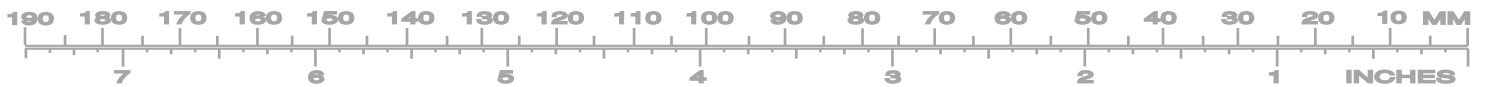



RS-5840 Shown

RS-5840

RS-5841

BONN

15mm blades

length 3^{1/2}"

straight, sharp

curved, sharp



RS-5850 Shown

RS-5850

RS-5851

Micro Dissecting

14mm blades

flat shanks & large rings

length 3^{3/4}"

straight, sharp

curved, sharp

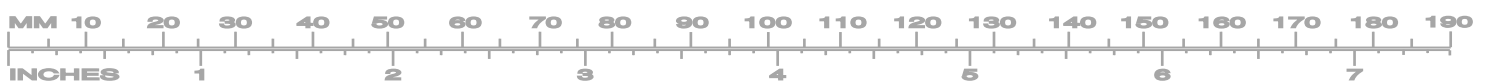

Micro Dissecting
 23mm blades
 flat shanks & large rings
 length 4"
 RS-5852 straight, sharp
 RS-5853 curved, sharp



RS-5852 Shown

RS-5859
 WILMER
 angled on flat
 sharp
 blade length 15mm
 length 4"



RS-5865
 Micro Dissecting
 curved
 flat shanks
 large finger rings
 blade length 19mm
 length 4"

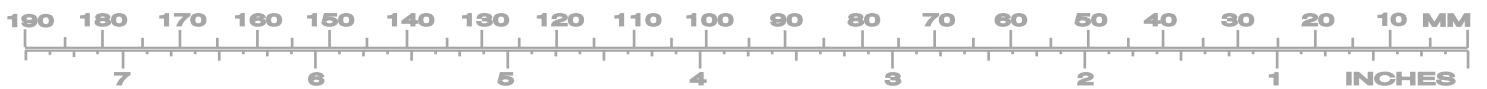



RS-5869

BIRO
 angled on flat
 sharp outside edges
 blade length 17mm
 length 4"



RS-5871

GRADLE
 slightly curved
 sharp points
 blade length 12mm
 length 4"



RS-5880

RS-5881

Micro Dissecting
 20mm blades
 length 3¹/₂"
 straight, sharp
 curved, sharp

RS-5880 Shown

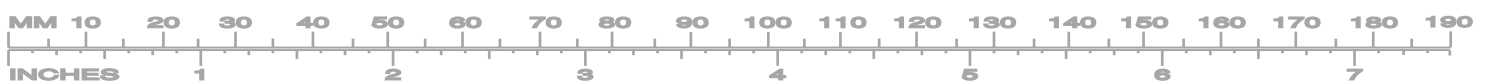

RS-5882 Micro Dissecting
length 4"
straight, sharp
blade length 24mm

RS-5883 curved, sharp
blade length 24mm



RS-5882 Shown

RS-5910 Micro Dissecting
blade length 23mm
length 3 1/2"
straight, sharp

RS-5911 curved, sharp



RS-5910 Shown

RS-5912 Micro Dissecting
straight, sharp
blade length 24mm
length 4 1/2"
standard

RS-5912L left handed version

RS-5912SC SURE CUT

RS-5914 carbide blades

RS-5914SC SURE CUT, carbide



RS-5912 Shown

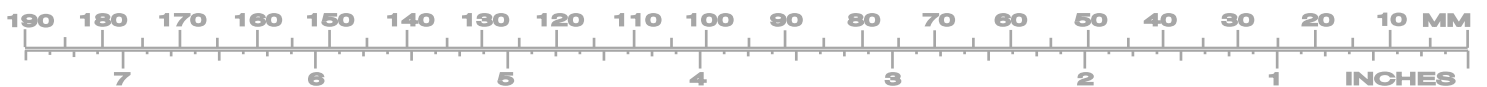



RS-5913 Shown

RS-5913 Micro Dissecting
 curved, sharp
 blade length 24mm
 length 4¹/₂"
RS-5913L standard
 left handed version
RS-5913SC SURE CUT
RS-5915 carbide blades
RS-5915SC SURE CUT, carbide



RS-5918 Micro Dissecting
 angled, sharp
 blade length 25mm
 length 4¹/₂"



RS-5921 Micro Dissecting
 curved on side, sharp
 blade length 22mm
 length 4¹/₂"



RS-5925 LA GRANGE
 double curve
 sharp serrated
 blade length 18mm
 length 4¹/₄"



RS-5928

OBRIEN
angular
blade length 14mm
length 3³/₄"



RS-5930

McGUIRE
curved on flat
blade length 15mm
length 4"



RS-5940

STEVENS
blade length 19mm
length 4¹/₄"

RS-5941

straight, sharp
curved, sharp

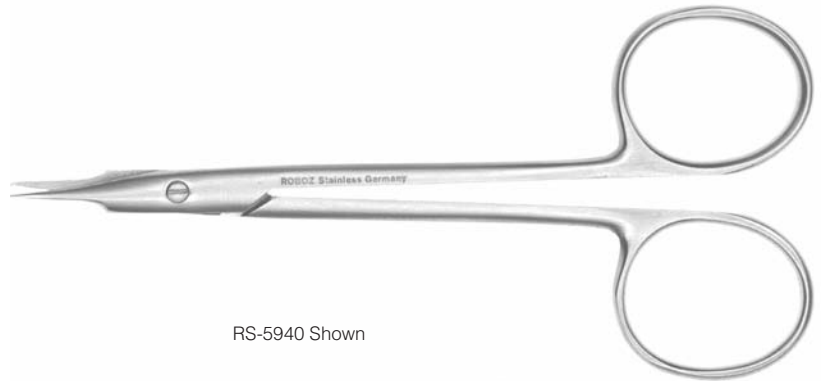

RS-5940 Shown

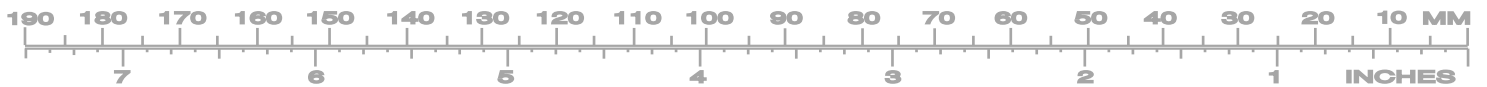



RS-5942 Shown

RS-5942

RS-5943

STEVENS

blade length 19mm

length 4¹/₄"

straight, blunt

curved, blunt

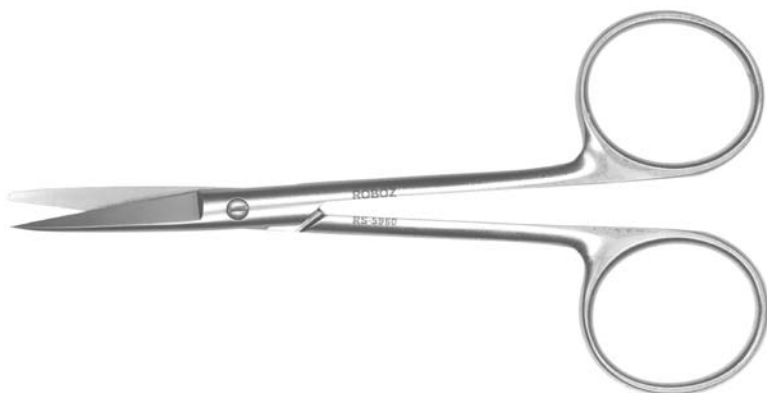

RS-5960 Shown

RS-5960

RS-5963

KNAPP

blade length 27mm

length 4"

straight, sharp-blunt

curved, sharp-blunt

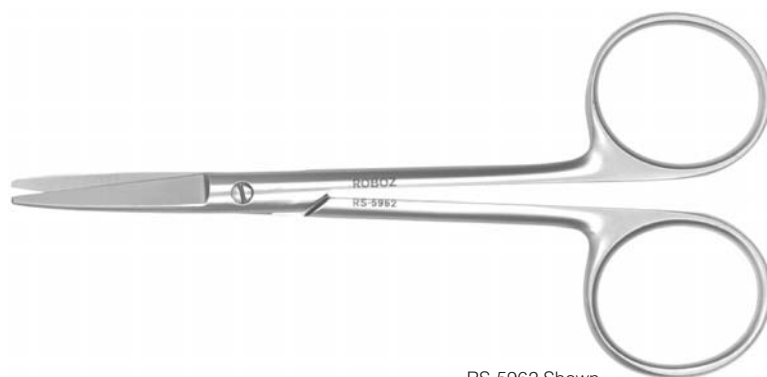

RS-5962 Shown

RS-5962

RS-5965

KNAPP

blade length 27mm

length 4"

straight, blunt-blunt

curved, blunt-blunt

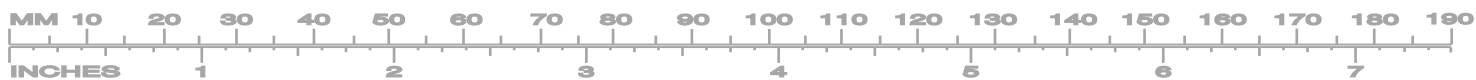

Micro Dissecting
blade length 22mm
length 4"
RS-5980 straight, blunt
RS-5981 curved, blunt

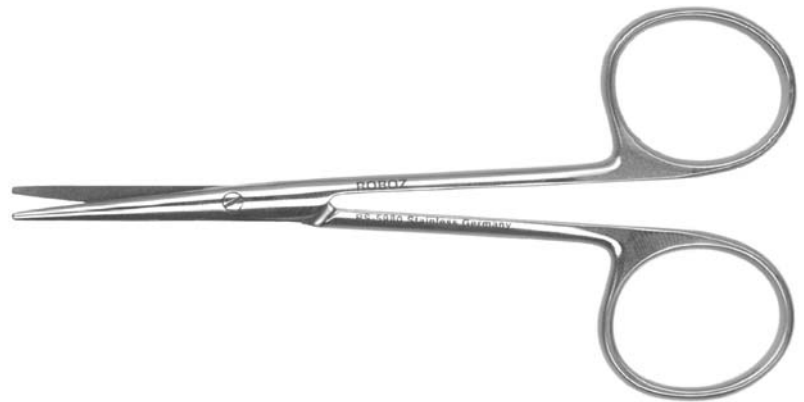

RS-5980 Shown

Micro Dissecting
blade length 25mm
straight
length 4 1/2"
RS-5982 blunt, standard
RS-5982L left handed version
RS-5984 blunt, carbide blades



RS-5983 Shown

Micro Dissecting
blade length 25mm
curved
length 4 1/2"
RS-5983 blunt, standard
RS-5983L left handed version
RS-5985 blunt, carbide blades

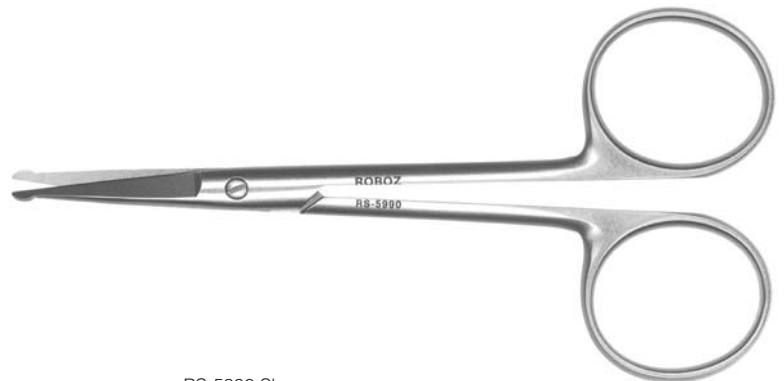

RS-5990 Shown

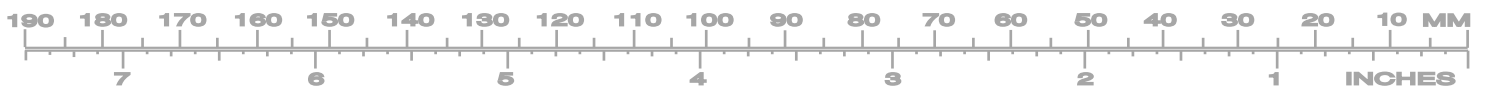



RS-5998

Micro Dissecting
angled
probe points
blade length 24mm
length 4^{1/2}"



RS-6010

METZENBAUM
length 5"

RS-6010SC

straight, blunt
blade length 25mm

RS-6013

SURE CUT
straight, blunt
blade length 25mm

RS-6013SC

curved, blunt
blade length 27mm

RS-6013 Shown



RS-6015

RAGNELL
curved
slender blunt points
blade length 27mm
length 5"

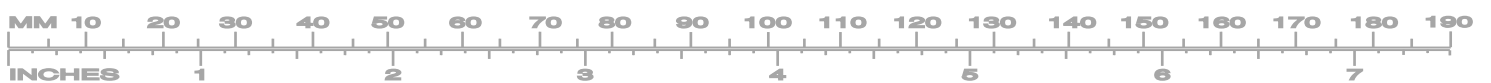

RS-6031
Micro Dissecting
blade length 40mm
length 5"
light curve, blunt

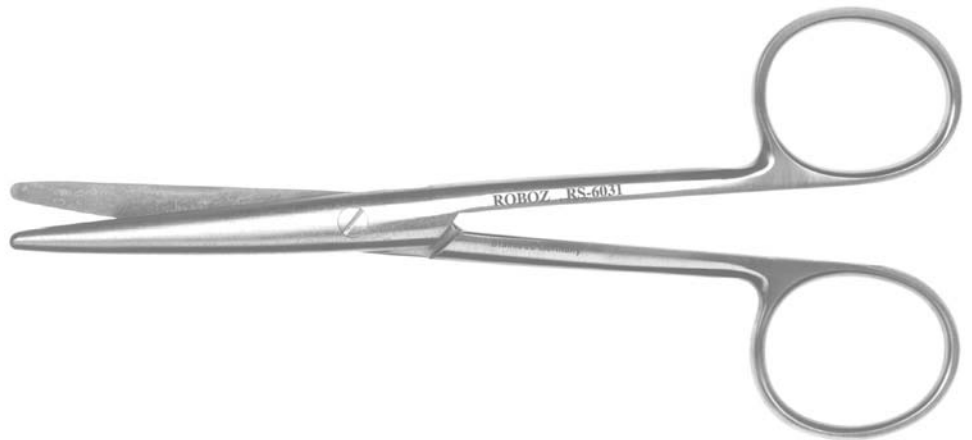

RS-6043
POTTS-SMITH
blade length 13mm
length 7"
45° angle

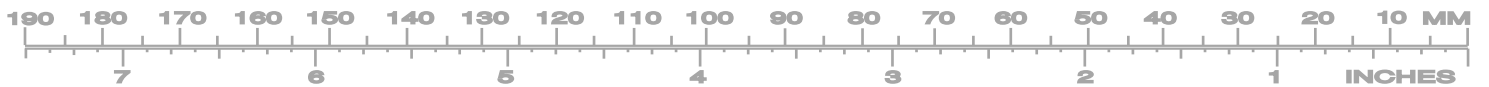
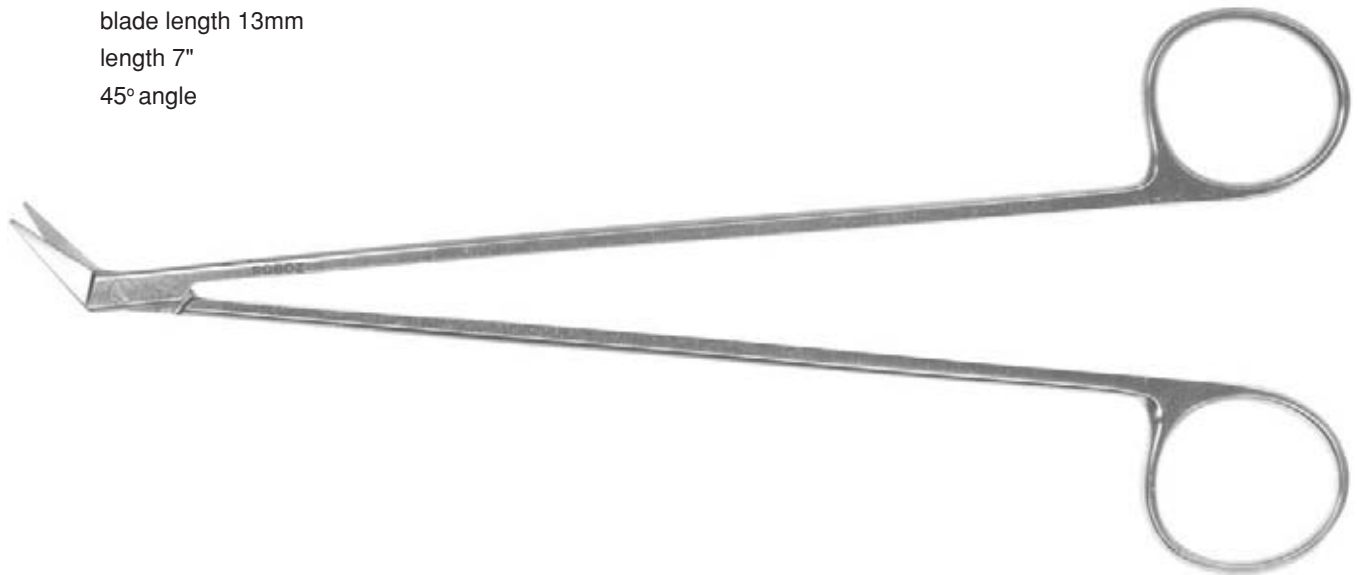

KELLY
blade length 29mm
length 6¹/₄"
straight, sharp
curved, sharp

RS-6050

RS-6051



RS-6050 Shown

RS-6058

KELLY
angled, sharp
blade length 29mm
length 6¹/₄"

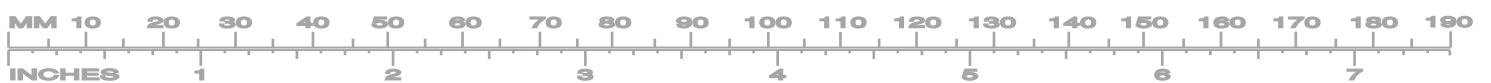

RS-6700
 RS-6706

Light Operating
 blade length 30mm
 length 4³/₄"
 straight, sharp-blunt
 curved, sharp-blunt



RS-6700 Shown

RS-6702
 RS-6703

Light Operating
 blade length 30mm
 length 4³/₄"
 straight, sharp-sharp
 curved, sharp-sharp

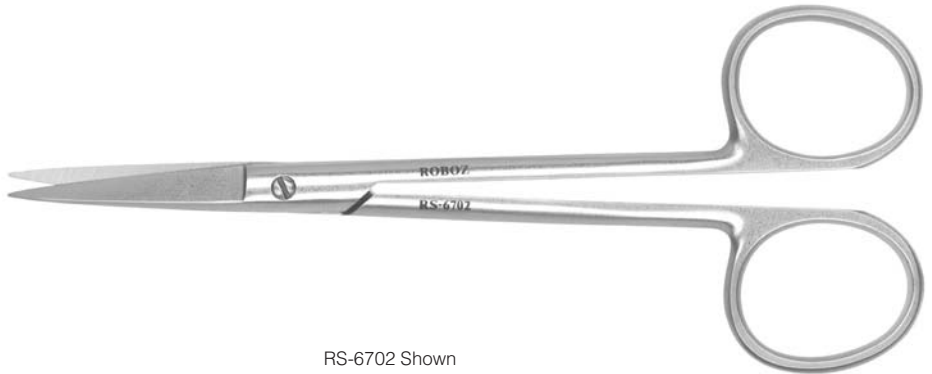

RS-6702 Shown

RS-6705

Light Operating
 curved, blunt
 blade length 30mm
 length 4³/₄"



RS-6708

Light Operating
 angled, sharp
 blade length 30mm
 length 4³/₄"

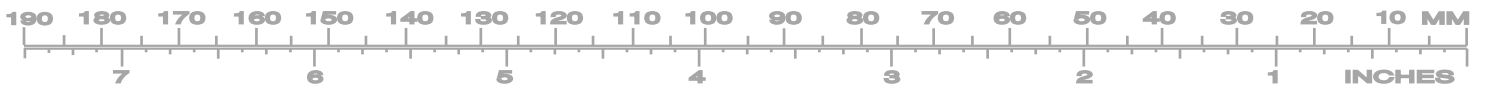

BROPHY

blade length 40mm

length 5^{1/2}"

straight, sharp

curved, sharp

RS-6730

RS-6731



RS-6730 Shown

Light Operating

blade length 40mm

length 5"

straight, sharp-blunt

curved, sharp-blunt

RS-6750

RS-6751



RS-6750 Shown

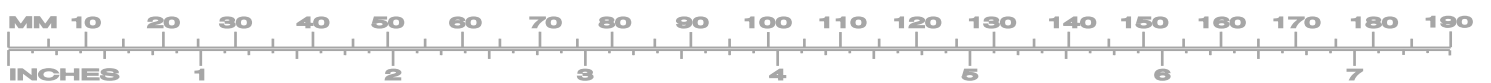

Light Operating
 blade length 40mm
 length 5"
 RS-6752 straight, sharp-sharp
 RS-6753 curved, sharp-sharp



RS-6752 Shown

Light Operating
 blade length 40mm
 length 5"
 RS-6754 straight, blunt-blunt
 RS-6755 curved, blunt-blunt



RS-6754 Shown

DEAVER
 blade length 43mm
 length 5 1/2"
 RS-6760 straight, sharp-blunt
 RS-6761 curved, sharp-blunt



RS-6760 Shown

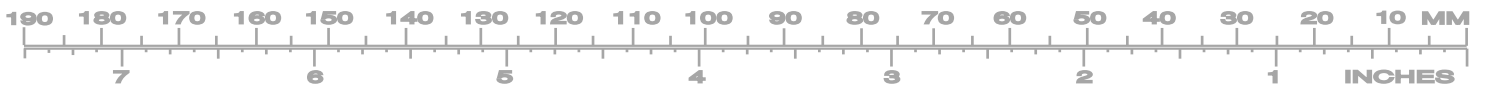

DEAVER

blade length 43mm

length 5¹/₂"

straight, sharp-sharp

curved, sharp-sharp

RS-6762

RS-6763



RS-6762 Shown

RS-6780

PERMA-SET

straight, sharp-blunt

blade length 45mm

length 5¹/₂"

RS-6782

PERMA-SET

straight, sharp-sharp

blade length 45mm

length 5¹/₂"

Operating
sharp-blunt

- RS-6800 straight, length 4¹/₂"
- RS-6806 straight, length 5"
- RS-6812 straight, length 5¹/₂"
- RS-6812SC SURE CUT, straight length 5¹/₂"
- RS-6818 straight, length 6"
- RS-6824 straight, length 6¹/₂"
- RS-6830 straight, length 7¹/₂"
- RS-6832 straight, carbide length 5¹/₂"
- RS-6837 curved, length 4¹/₂"
- RS-6843 curved, length 5¹/₂"
- RS-6843SC SURE CUT, curved length 5¹/₂"
- RS-6849 curved, length 6¹/₂"



RS-6812 Shown

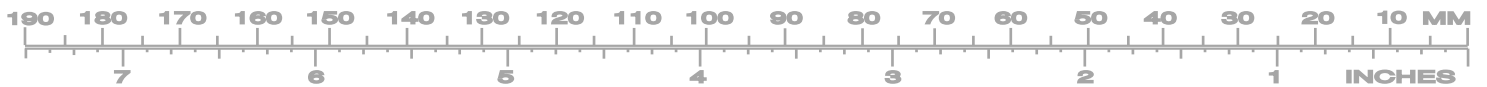

Operating
sharp-sharp

RS-6802	straight, length 4 ¹ / ₂ "
RS-6808	straight, length 5"
RS-6814	straight, length 5 ¹ / ₂ "
RS-6820	straight, length 6"
RS-6826	straight, length 6 ¹ / ₂ "
RS-6834	straight, carbide length 5 ¹ / ₂ "
RS-6839	curved, length 4 ¹ / ₂ "
RS-6845	curved, length 5 ¹ / ₂ "
RS-6851	curved, length 6 ¹ / ₂ "



RS-6814 Shown

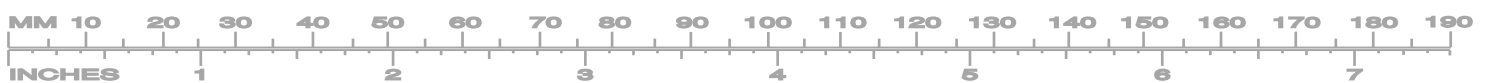

Operating
blunt-blunt

- RS-6804 straight, length 4¹/₂"
- RS-6810 straight, length 5"
- RS-6816 straight, length 5¹/₂"
- RS-6822 straight, length 6"
- RS-6828 straight, length 6¹/₂"
- RS-6841 curved, length 4¹/₂"
- RS-6847 curved, length 5¹/₂"
- RS-6853 curved, length 6¹/₂"



RS-6816 Shown

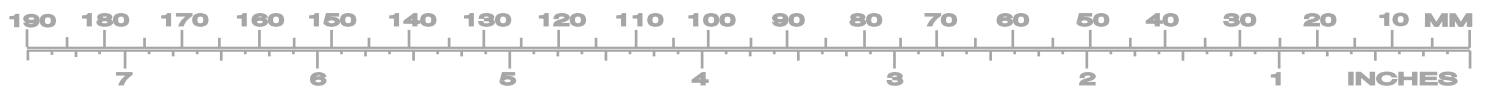

MAYO
straight

RS-6870	blade length 43mm length 5 ¹ / ₂ "
RS-6870SC	SURE CUT blade length 43mm length 5 ¹ / ₂ "
RS-6872	blade length 53mm length 6 ³ / ₄ "
RS-6872L	left handed version
RS-6872SC	SURE CUT blade length 53mm length 6 ³ / ₄ "
RS-6874SC	SURE CUT blade length 56mm length 9"
RS-6880	carbide blades blade length 43mm length 5 ¹ / ₂ "
RS-6882	carbide blades blade length 53mm length 6 ³ / ₄ "



RS-6870 Shown

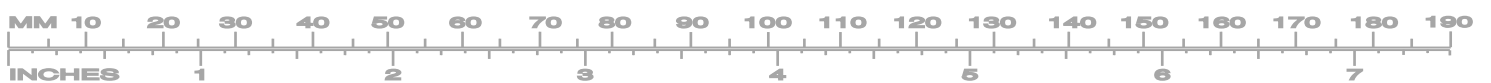

- MAYO
curved
- RS-6871 blade length 43mm
length 5¹/₂"
- RS-6871SC SURE CUT
blade length 43mm
length 5¹/₂"
- RS-6873 blade length 53mm
length 6³/₄"
- RS-6875SC SURE CUT
blade length 63mm
length 9"
- RS-6881 carbide blades
blade length 43mm
length 5¹/₂"
- RS-6883 carbide blades
blade length 53mm
length 6³/₄"



RS-6873 Shown

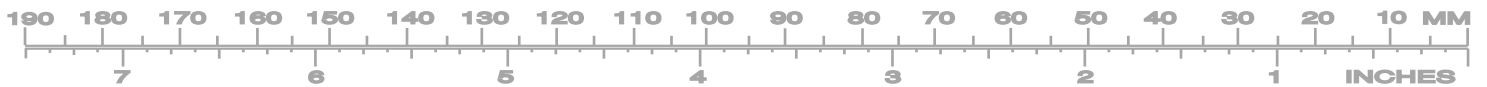

MAYO-STILLE
rounded blades

RS-6890 straight
blade length 42mm
length 5¹/₂"

RS-6892 straight
blade length 49mm
length 6³/₄"

RS-6891 curved
blade length 42mm
length 5¹/₂"

RS-6893 curved
blade length 49mm
length 6³/₄"



RS-6890 Shown



MAYO-NOBLE
blade length 48mm
length 6¹/₂"

RS-6920 straight
RS-6921 curved



RS-6920 Shown

DOYEN
abdominal
blade length 67mm
length 7"

RS-6930 straight
RS-6931 curved



RS-6930 Shown

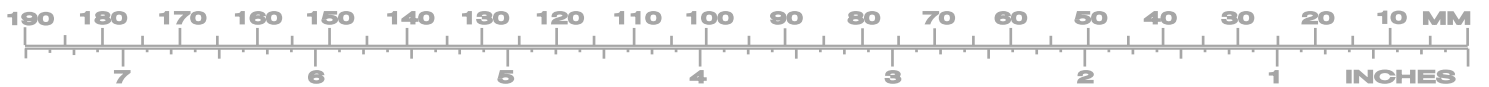

Veterinary
heavy pattern
sharp-blunt, serrated
blade length 57mm
length 6¹/₂"

RS-6940

straight

RS-6941

curved



RS-6940 Shown

Veterinary
heavy pattern
blunt-blunt, serrated
blade length 57mm
length 6¹/₂"

RS-6942

straight

RS-6943

curved



RS-6942 Shown



RS-6947
DuBOIS
decapitation
curved, serrated
blade length 57mm
length 10^{1/2}"



50% of Actual Size

METZENBAUM
straight

RS-6950
blade length 39mm
length 5^{1/2}" (Lahey)
RS-6952
blade length 35mm
length 7" (Lahey)
RS-6952L
left handed version



RS-6950 Shown

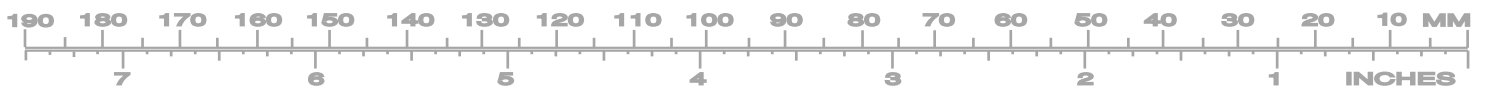

METZENBAUM
extra delicate
curved
blade length 39mm

RS-6959	length 6"
RS-6957	length 7"
RS-6956	carbide blades length 7"
RS-6954SC	SURE CUT length 7"

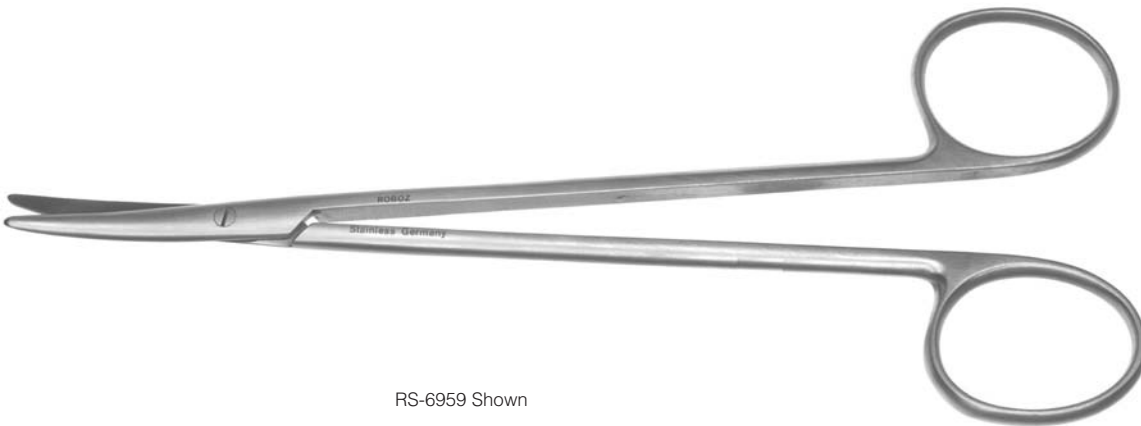

RS-6959 Shown

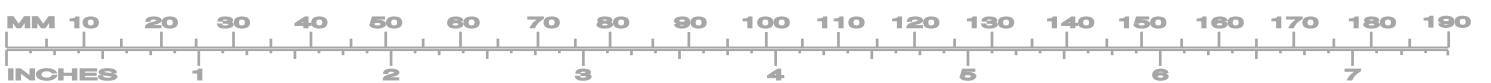

METZENBAUM
curved

- RS-6951 blade length 39mm
length 5^{1/2}" (Lahey)
- RS-6951SC SURE CUT
blade length 39mm
length 5^{1/2}" (Lahey)
- RS-6958 carbide blades
blade length 39mm
length 5^{1/2}" (Lahey)
- RS-6953 blade length 35mm
length 7" (Lahey)
- RS-6953L blade length 35mm
length 7" (Lahey)
Left Hand Version
- RS-6953SC SURE CUT
blade length 35mm
length 7" (Lahey)
- RS-6955SC SURE CUT
carbide blades
blade length 35mm
length 7" (Lahey)
- RS-6973 blade length 49mm
length 9" (Nelson)
- RS-6974 carbide blades
blade length 49mm
length 9" (Nelson)



RS-6951 Shown

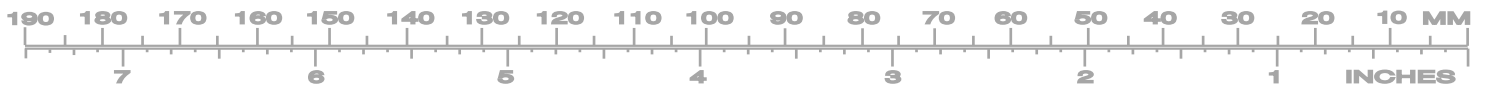

RS-7010

RS-7011

KAHN

blade length 32mm

straight

length 5³/₄"

curved

length 5³/₄"

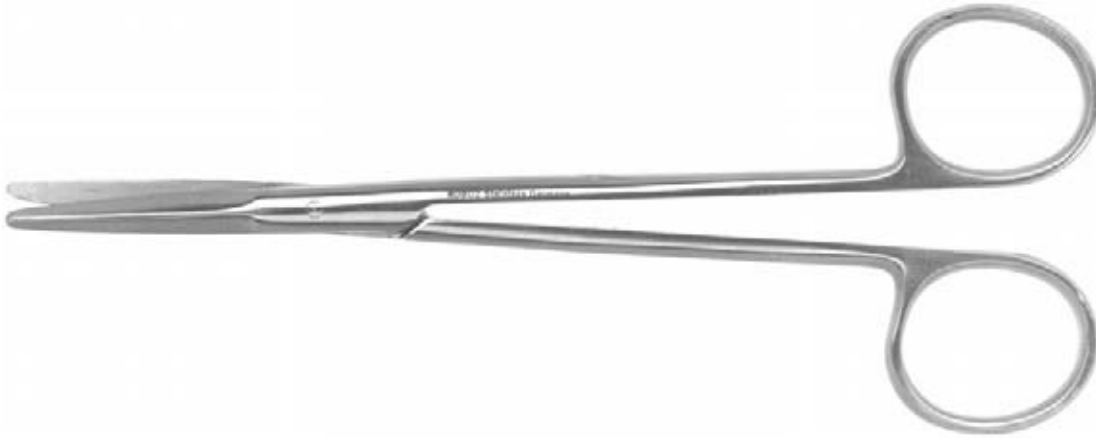

RS-7010 Shown

RS-7030

RS-7031

SIMS

blade length 48mm

length 8"

straight, sharp-sharp

curved, sharp-sharp



RS-7030 Shown
75% of Actual Size

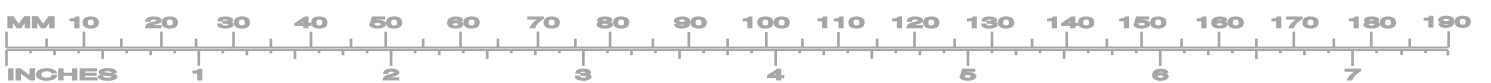

RS-7041

DEAN
blades angled on flat
one serrated blade
slightly curved handles
blade length 21mm
length 6³/₄"



RS-7045

REYNOLDS
curved
tenotomy tips
blade length 35mm
length 6"



RS-7045 Shown

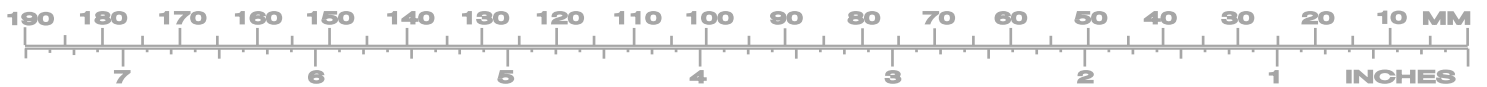

RS-7047

MARTIN
cartilage
serrated
blade length 48mm
length 7³/₄"

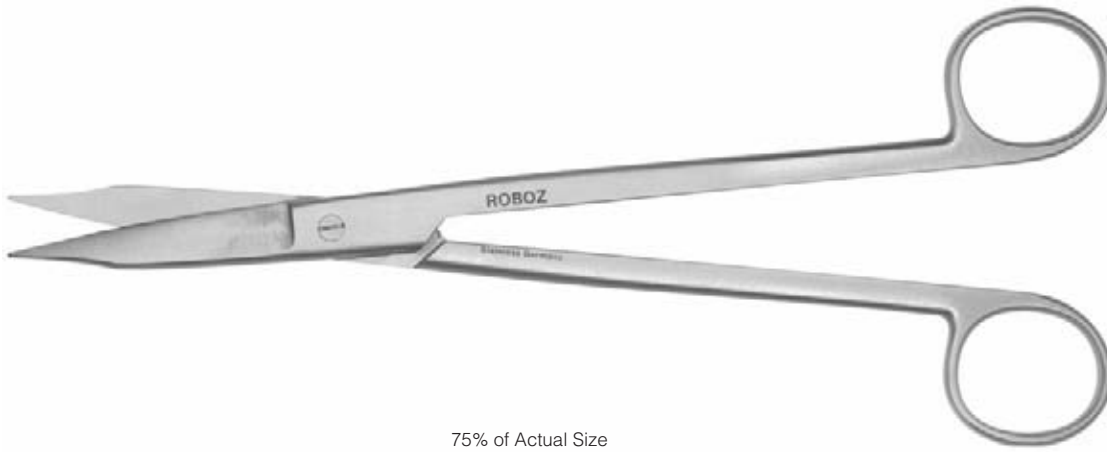

75% of Actual Size

RS-7055

HERCULES
heavy duty
serrated
length 7¹/₂"

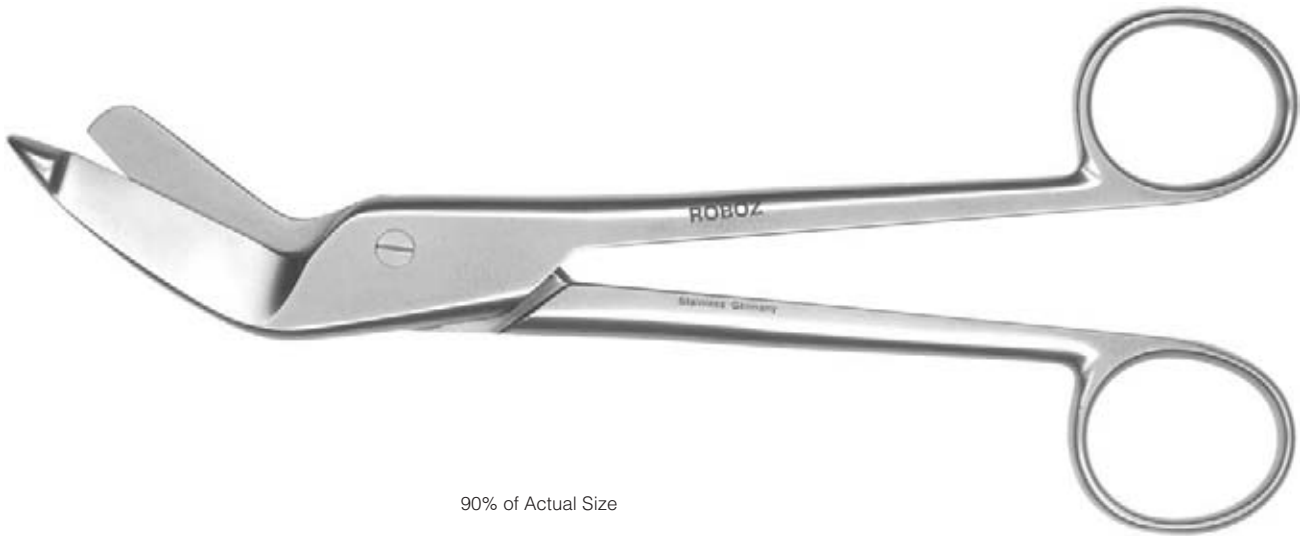

90% of Actual Size

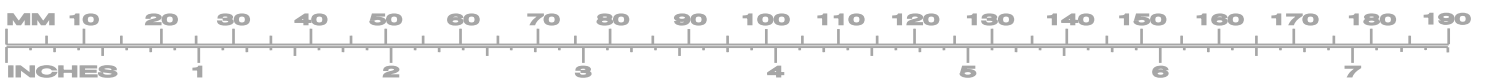

RS-7060

Enterotomy
hook blade
length 8¹/₂"



75% of Actual Size

RS-7084

LISTER
bandage
length 4¹/₂"

RS-7085

length 5¹/₂"



RS-7084 Shown

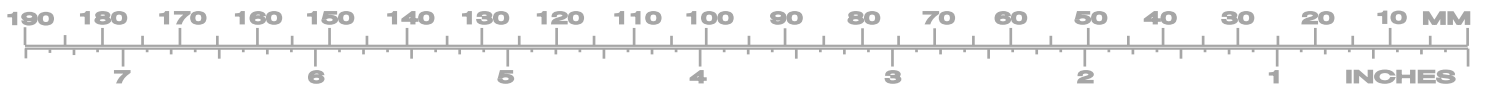

RS-7097

Extra Heavy Duty
hardened steel
serrated
length 7³/₄"



90% of Actual Size

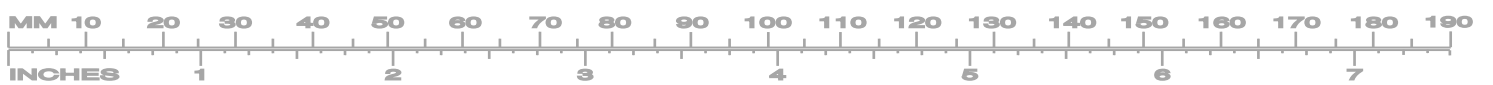

RS-7098
ESMARCH
bandage
and plaster shears
length 8"



75% of Actual Size

RS-7099L
All Purpose
bandage/utility
serrated, autoclavable
black plastic handles
length 7¹/₂"



90% of Actual Size

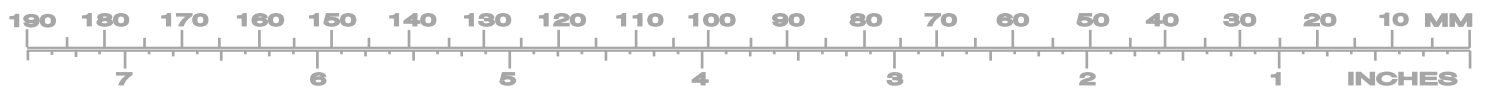

RS-7099S

All Purpose
bandage/utility
serrated, autoclavable
black plastic handles
length 6¹/₂"

